

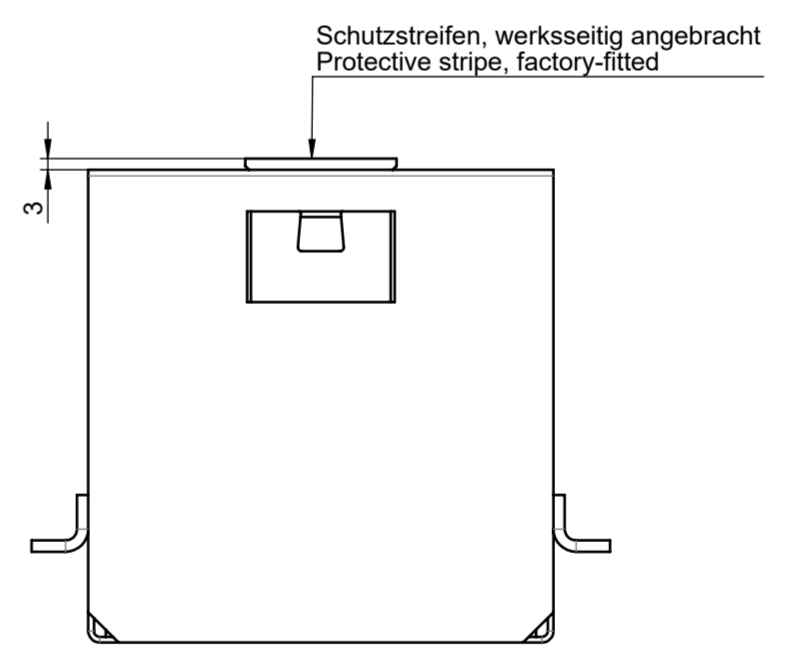

1 2 3 4 5 6 7 8 9 10 11 12

A
B
C
D
E
F
G
H

SCALE 1 : 5

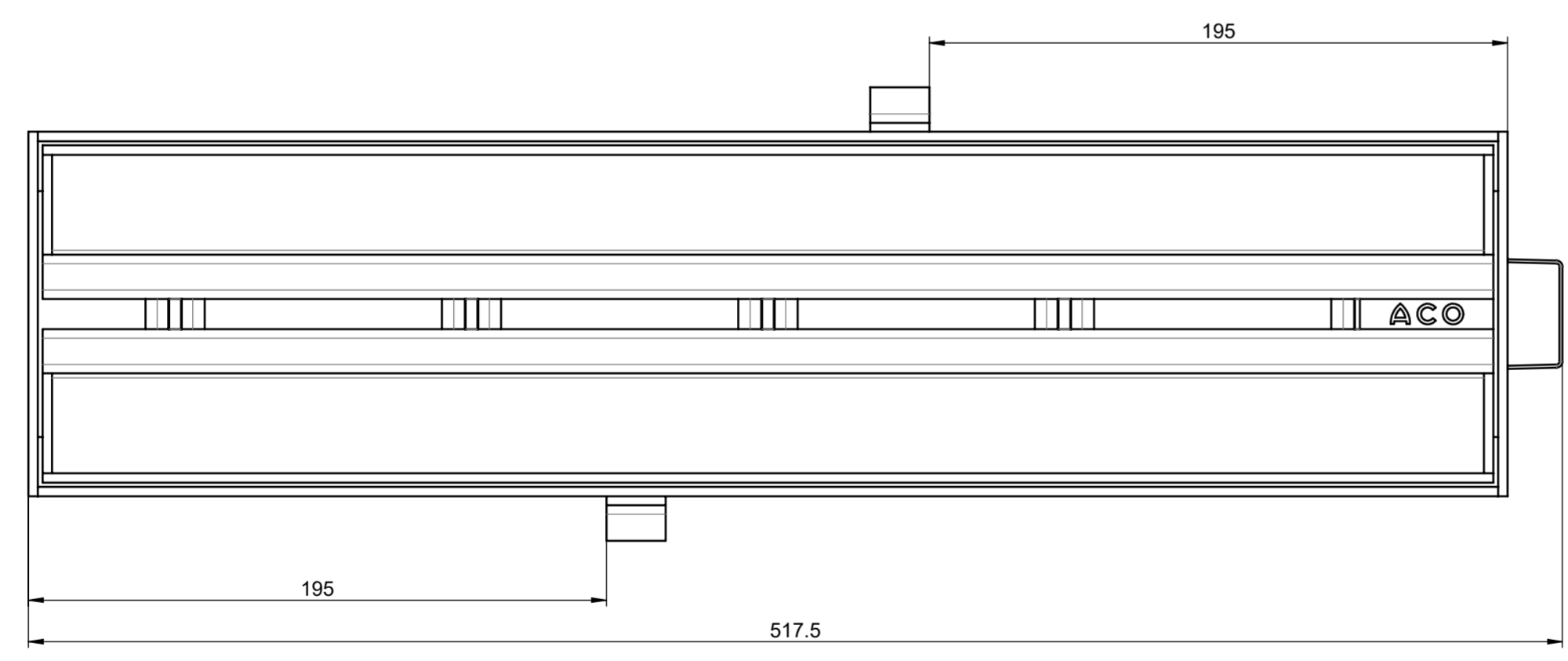
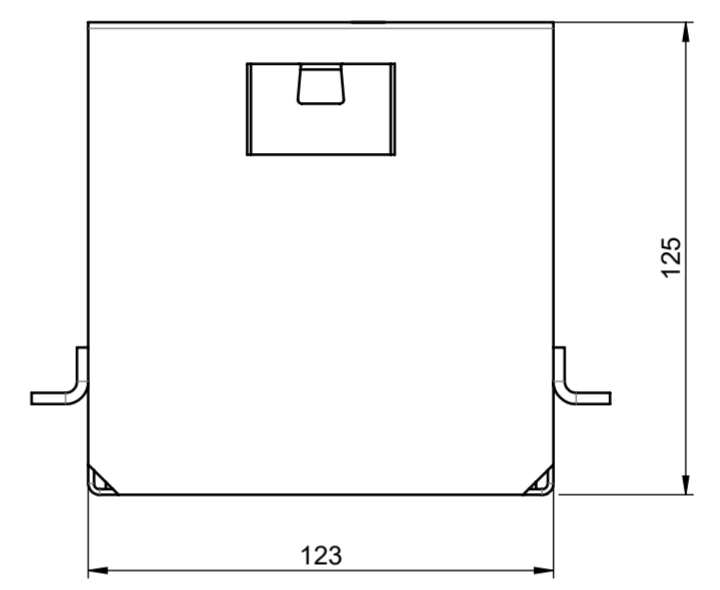
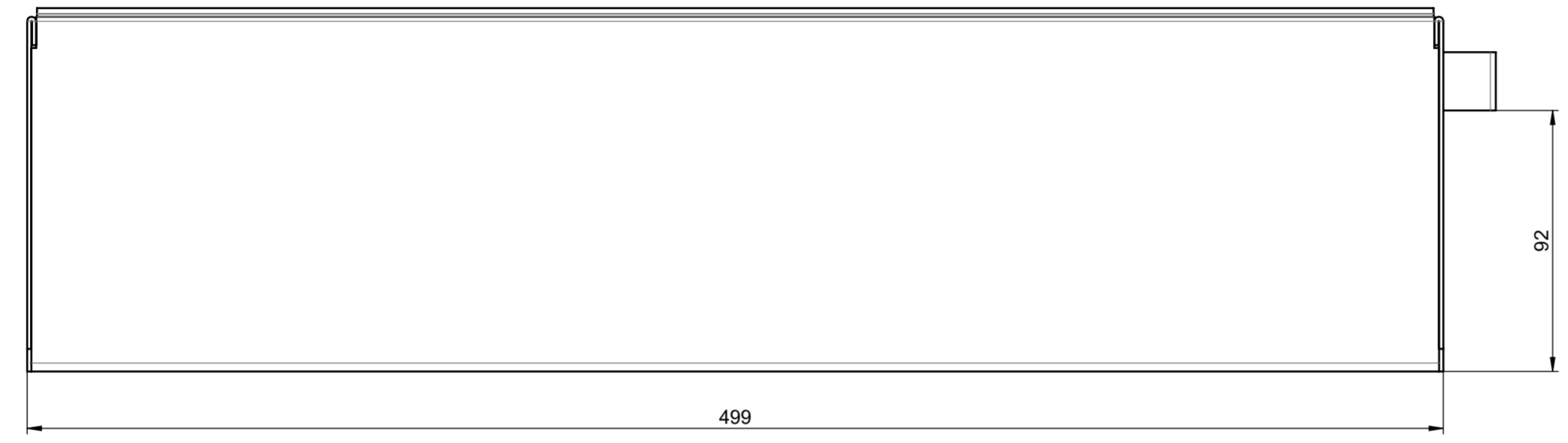
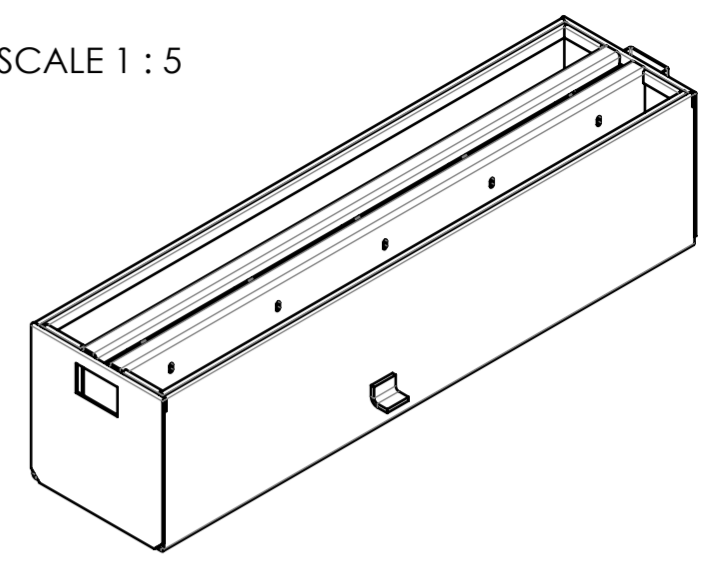

local article number: 445946

	ACO Tiefbau Vertrieb GmbH 24755 Rendsburg, Postfach 320 Tel. 04331 / 354-500 Fax. 04331 / 354-358 www.aco.com	drawing-no.: 1070776-M	index: 001	documenttype: marketing drw.
		created by: rbhatia	reviewed by: rbhatia	projection: ISO-E 

title:
ACO SlotTop
SlotTop AU V100 H105 C250 Stripe 10mm L0.5m, Stainless steel
Schlitzrahmen AU V100 H105 C250 Streifen 10mm L0.5m, Edelstahl

The reproduction, distribution and utilization of this document as well as the communication of its contents to others without express authorization is prohibited. Offenders will be held liable for the payment of damages. All rights reserved in the event of the grant of a patent, utility model or design. Observe copyright by ISO 16016

release date:
19-Nov-2018 14:53

sheet:
1/1

1 2 3 4 5 6 7 8 9 10 11 12