

Beépítési útmutató
ACO kerb single, double



ENG Installation Manual

GER Installationsanleitung

FRA Instructions d'installation

ESP Manual De Instalación

POR Manual de Instalação

ITA Manuale d'installazione

NLD Installatiehandleiding

CZE Instalační manuál

RUS Инструкция По Установке

SWE Installationsanvisning

NOR Installasjons Manual

FIN Asennusohje

DAN Installationsvejledning

EST Paigaldusjuhend

LAV Uzstādīšanas instrukcija

LIT Montavimo instrukcija

POL Instrukcja montażu

BUL Инструкции за инсталация

HUN Beépítési útmutató

RUM Instrucțiuni de instalare

HRV Upute za ugradnju

SLV Navodila za vgradnjo

SRP Preporuka za ugradnju



2-5

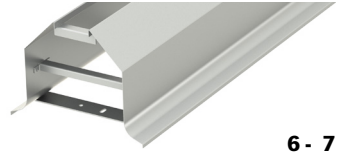

6-7

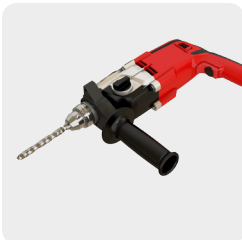
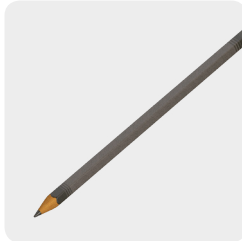
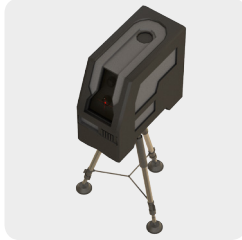

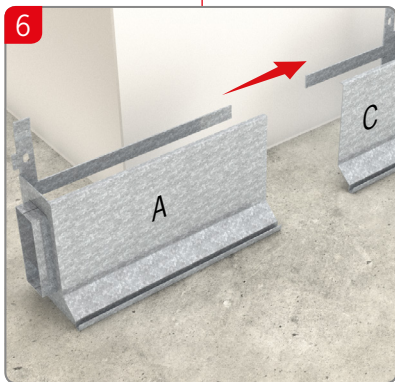
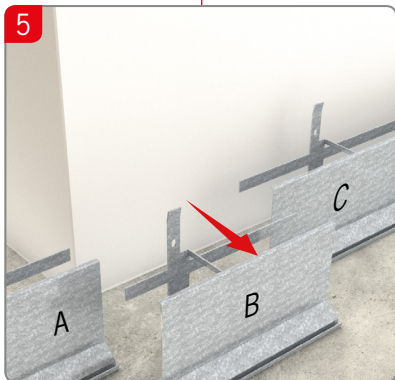
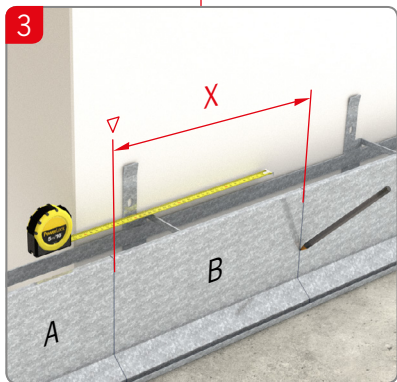
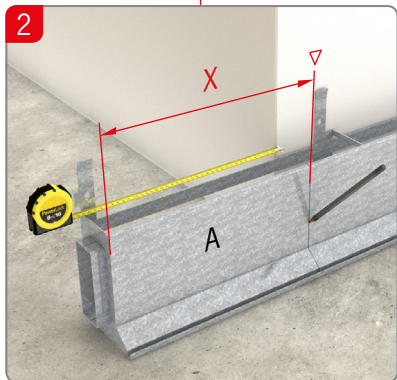
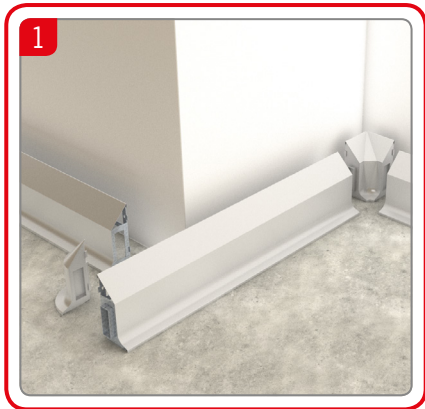

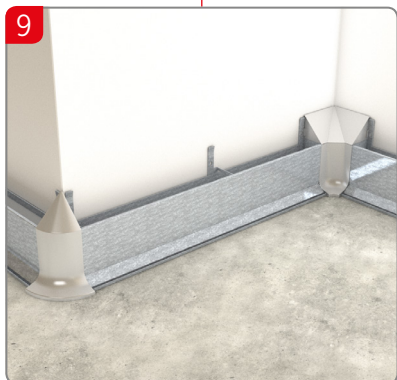
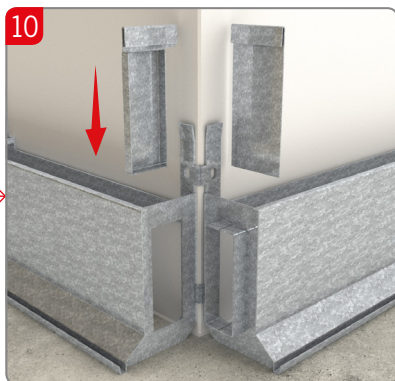

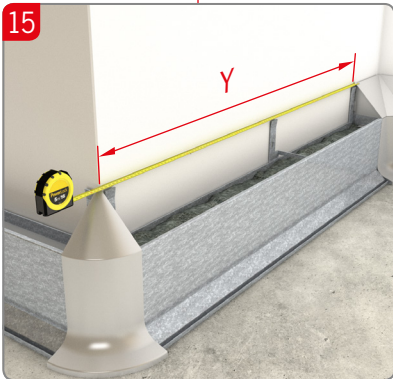
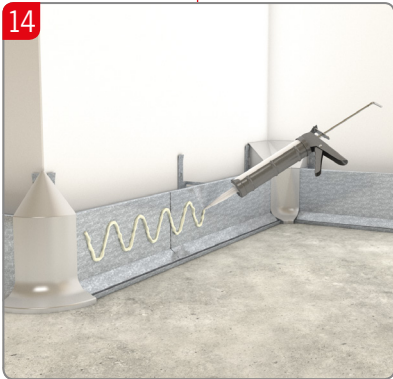
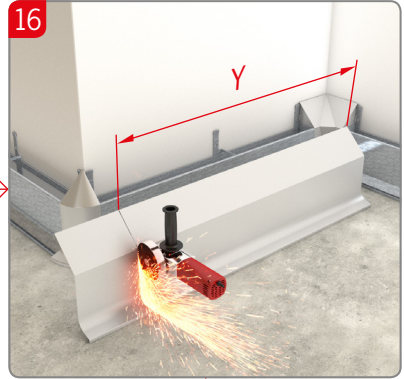
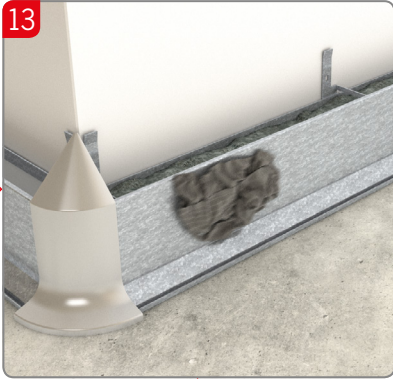

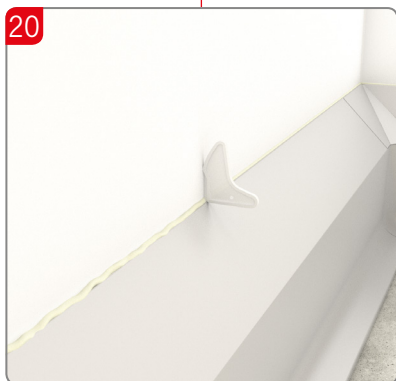

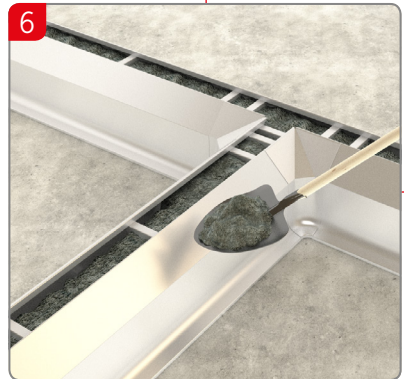
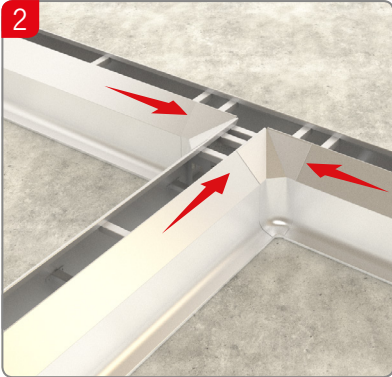
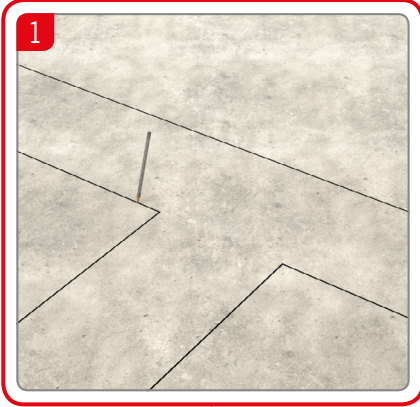
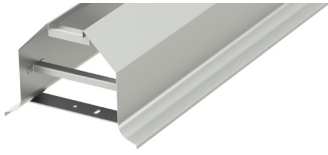



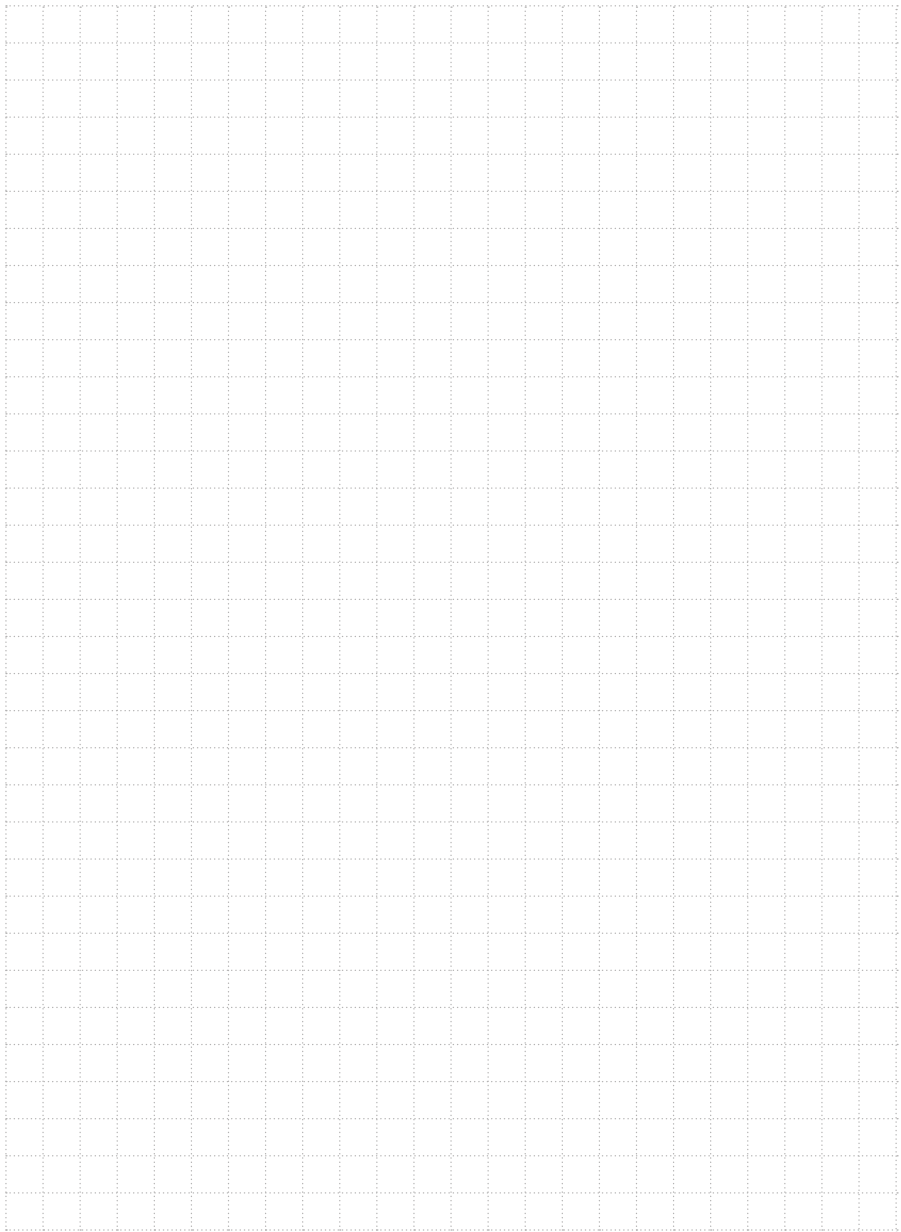

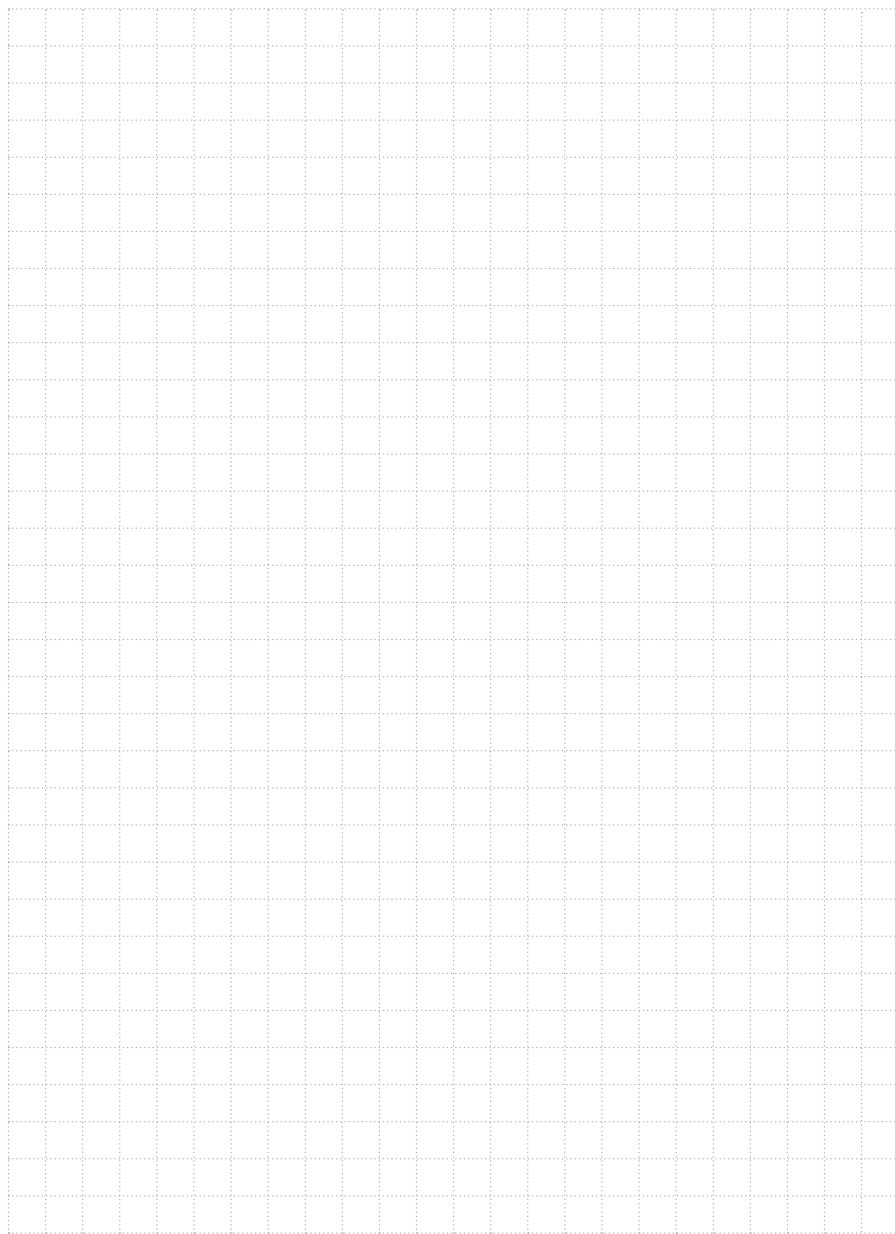

ACO. creating the future of drainage

www.aco.hu



+



→

